



Instruction Manual

WK-HUB

Rako Wired Ethernet Hub



2024
Version 1.4.5



For programming a wired system: "[Wired System Programming Guide](#)"

Contents:

[1 Functions of the WK-HUB](#)

[2 Installing the WK-HUB](#)

[3 Discovering the HUB and Setting the House Number](#)

[3.1 Discovering the HUB](#)

[3.2 Setting up the HUB using the Web Page Wizard](#)

[3.3 Managing the HUB House number](#)

[3.4 If you cannot connect to the HUB](#)

[4 Linking the HUB for cloud services](#)

[4.1 Where to find each cloud service](#)

[4.2 Linking the HUB to Cloud services](#)

[5 Adding the HUB as a device to Rasoft Pro](#)

[6 Uploading the project file](#)

[7 Downloading the project file](#)

[8 Events](#)

[8.1 Setting Events using Rasoft Pro](#)

[8.2 Setting Events using the Rako App](#)

[9 Activities](#)

[9.1 Setting Events using Activities](#)

[9.2 Setting Audio Activities](#)

[10 Mappings](#)

[10.1 Mapping wireless commands to give multi-room functionality](#)

[10.2 Triggering Macros from Maps](#)

[11 Macros](#)

[11.1 Writing Macros](#)

[11.2 Triggering Macros](#)

[12 Holiday Mode](#)

[13 Upgrading the HUB](#)

[14 UDP Feedback](#)

[14.1 Live feedback](#)

[14.2 UDP feedback log](#)

[14.3 HUB Webpages logs](#)



1 Functions of the WK-HUB

The WK-HUB will add the following features to a Rako wired system:

- Network interface: Local programming, App control, and IP integration of 3rd party control systems.
- Cloud Gateway: Interfaces with Amazon Alexa, Google Home, Apple Homekit, Sonos, etc.
- Storing Project file information: Room, Channel and Scene information can be stored.
- Timed Events: Automatic functions at fixed times including dawn & dusk.
- Mapping: Commands can be redirected to perform other tasks.
- Macros: Series of commands that are triggered by a single command or event. Specific steps can be enabled and disabled, giving conditional functionality.
- Holiday Mode: Replays recorded Scene activity, creating an occupied look to a property.
- Wired-Wireless Interface: The WK-HUB functions as an interface between wireless signals and the wired network.

2 Installing the WK-HUB

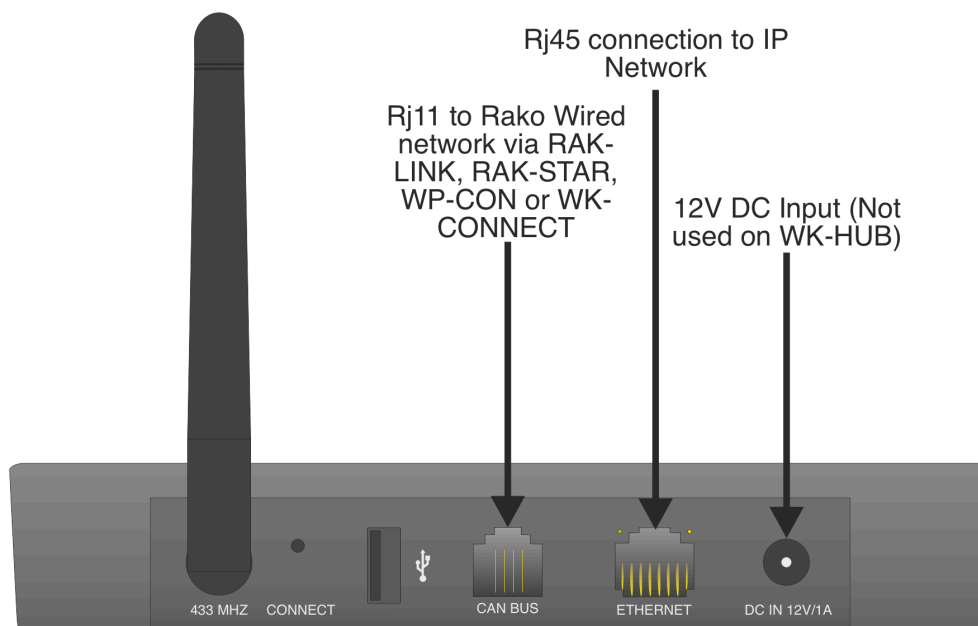

- Step 1: Plug RJ11 cable provided into the WK-HUB and an available RJ11 port into the RAK-LINK.
- Step 2: Plug the Ethernet patch cable from the WK-HUB to a spare port in a router or network switch.
- Step 3: Mount the WK-HUB to a wall using the fixing bracket if desired.

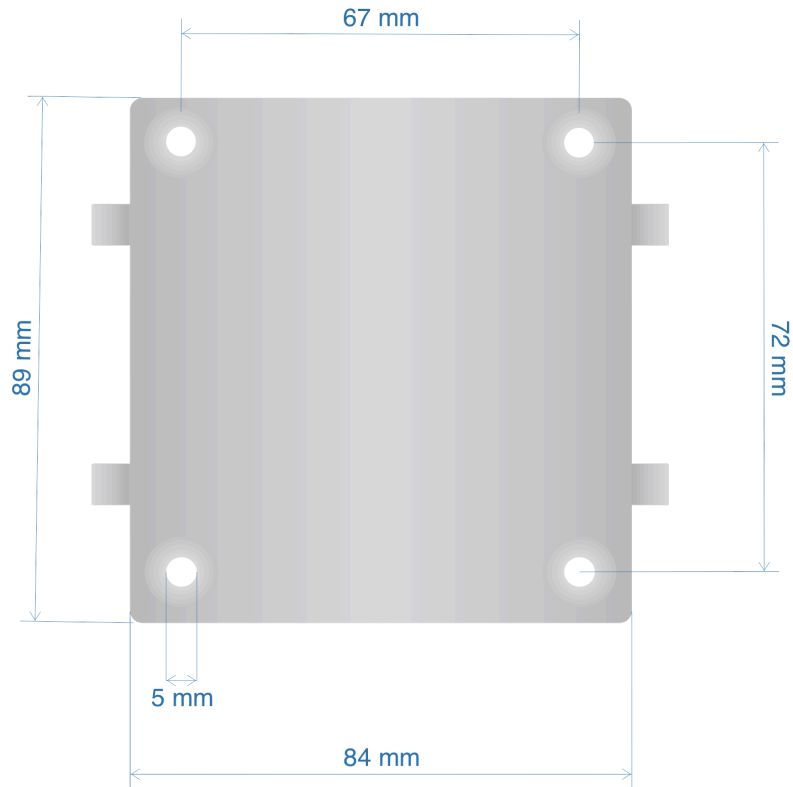

3 Discovering the HUB and Setting the House Number

Before proceeding with any programming, the HUB needs to be discovered and the House number set. This is done via a web page setup wizard.

3.1 Discovering the HUB

Open the Rasoft Pro programming software. Ensure that the laptop is connected to the same network as the HUB.

The HUB should appear in the "Communication" window in the bottom right of the software with a red stop sign. If it does not appear, press "Refresh." If it still does not appear, refer to [section 3.4](#) of this manual.

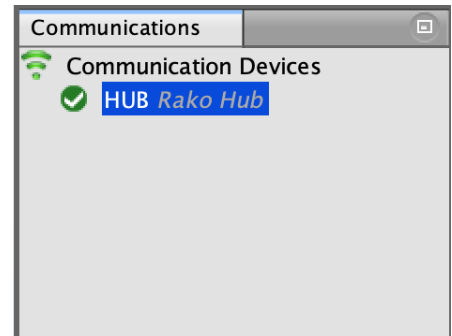

3.2 Setting up the HUB using the Web Page Wizard

To access the HUB Web Pages, right-click the Communication Device in the bottom-right section of the software. Select "Open in Browser."

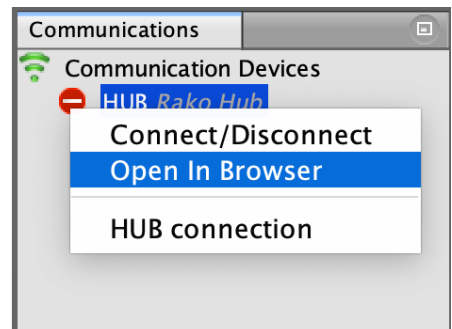

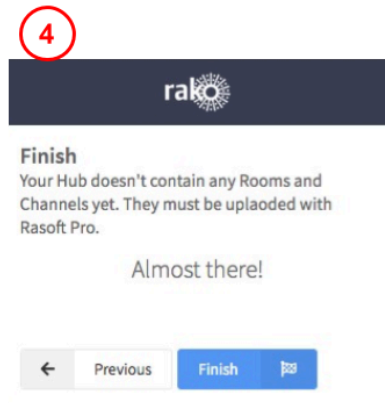
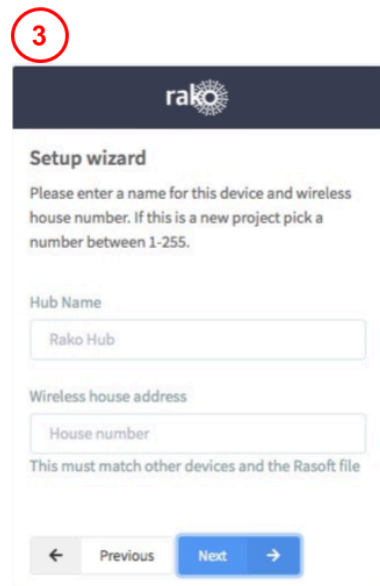
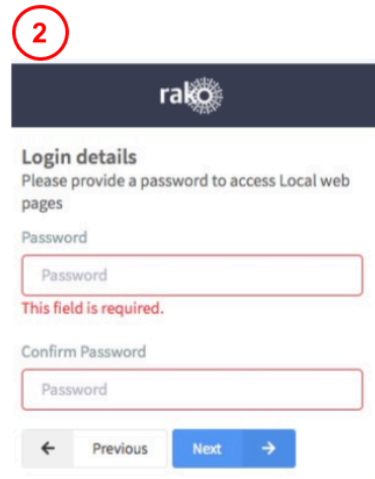
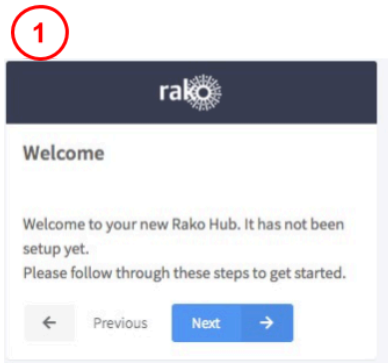

- Step 1: Welcome page; select “Next” to begin setup.
- Step 2: Set a password; this will be used to login to the webpages. It will also be the password used to login to the App if a password is required.
- Step 3: Set the House number of the HUB. This should match the Rasoft Pro project file as defined in the “New Project Wizard.” It is important that this is set up correctly at this stage, as it will define the House number for the rest of the system.
- Step 4: Select “Finish” to complete setup.

3.3 Managing the HUB House number

Using the HUB on the default House address of 1 is strongly discouraged. Leaving the House number at 1 drastically increases the likelihood of interference from nearby Rako systems.

The HUB always has a default House Address of 1, if it has not been set up before. Before programming using the HUB, it is important to ensure the HUB House number corresponds to the Project File House number.

To change the House number if the HUB has already been set up as described in 3.2, see below:

1) Project File House number can be found in the software at the top of the Room List

2) Select "Configuration" to open page as shown

3) Set "Wireless House Address" to match Project File. So change from 1 to 92

4) Click "Update" to save changes

As a final check, it is advisable to disconnect and reconnect to the HUB by double-clicking the HUB:

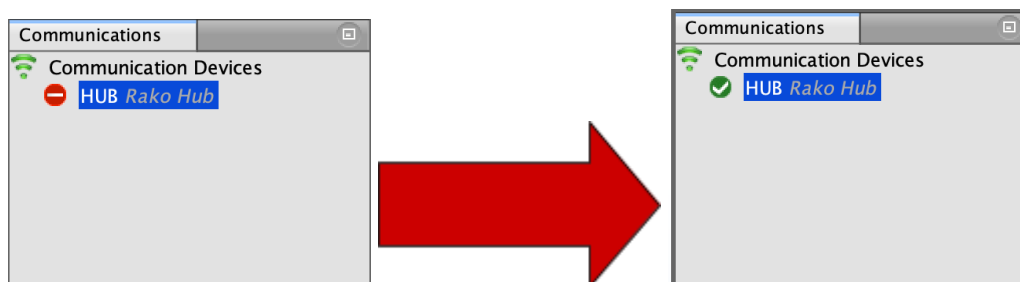

If no pop-up box appears, then the HUB House number and Project File House number are the same.

WARNING

If a pop-up box appears with a warning about the House number, click "Cancel." Do not continue programming if there is a conflict between the "Project File House Number" and the "HUB House Number".

3.4 If you cannot connect to the HUB

If the software cannot connect to the HUB, first restart the software and ensure that it is fully updated. If the HUB still does not appear, it is most likely a networking issue. If this problem cannot be solved, then the HUB can be connected point-to-point using a standard Ethernet cable.

4 Linking the HUB for cloud services

To be able to access cloud services, the HUB must be linked to a my.rakocontrols.com account.

4.1 Where to find each cloud service

Some cloud services are configured and customised from the HUB webpage, whereas others are from my.rakocontrols.com

- HUB webpage: Sonos Activities (new cloud API and “ACM” style custom IP strings) including custom and default templates (RCM/WCM-audio style keypads)
- my.rakocontrols.com: Amazon Alexa, Google Home and Apple Home, including “Custom Scenes” and advanced Apple Home configuration (Channel and Room mode etc.)

NB

More detailed descriptions of how to use the more advanced settings within the cloud services are linked from the relevant section of either the HUB webpages or my.rakocontrols.com

4.2 Linking the HUB to Cloud services

Use the HUB webpages to link to cloud services. Navigate to the “Cloud” section from the menu on the right hand side of the screen.

- Step 1: Press “Connect”: this will link you to the my.rakocontrols.com page.

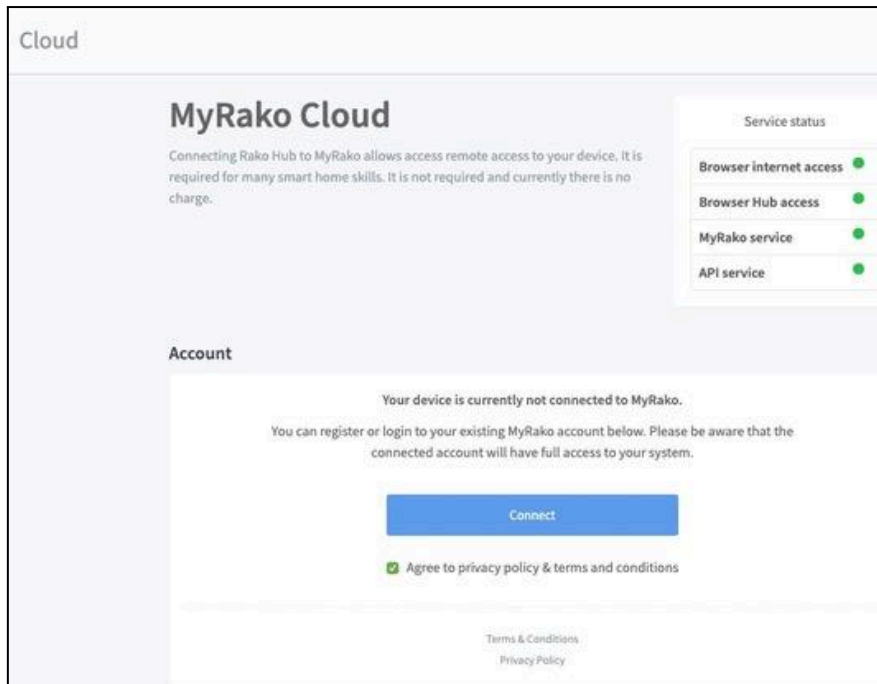

Make sure that all “Service Status” indicators are green before proceeding with the following steps.

- Step 2: Press “Login/Register” if you already have a my.rakocontrols.com account; use the email and password that are used for this; if not, create an account.

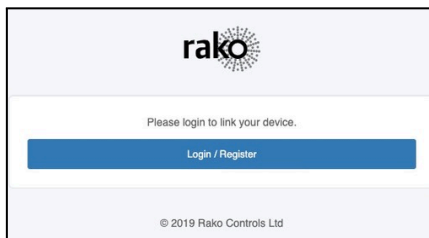

- Step 3: Once logged in, the code within the HUB will be automatically verified.

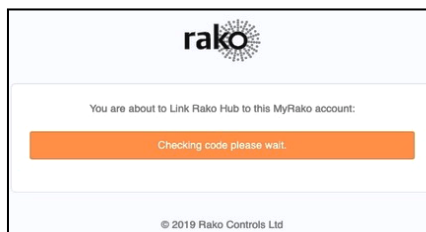

- Step 4: Once linked, the HUB will ask to be given a “Nickname”. This is how it will be referred to in the my.rakocontrols.com interface. It does not need to be the same as the “HUB name” as defined within the HUB setup wizard.

Once completed, the my.rakocontrols.com “Devices” page should appear as below:

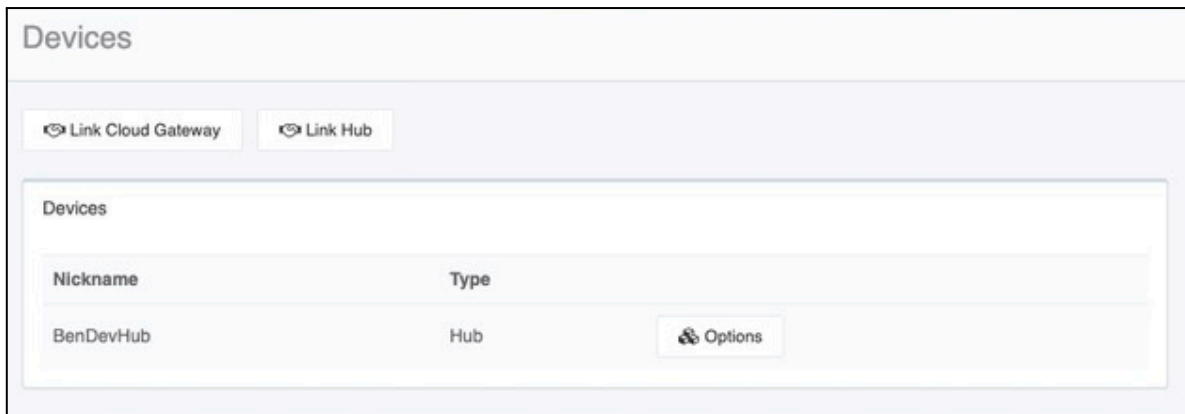

5 Adding the HUB as a device to Rasoft Pro

Once the WK-HUB has been successfully connected, it will need to be added to the software as a device.

- Step 1: Select "File" - "New Device" to open the new device wizard. Choose "Bridge" as the device to be added.
- Step 2: Select "Next" on the "Assign to Room" step. No room or channel needs to be associated with the HUB.
- Step 3: Select the HUB from the list; it will appear if you are successfully connected in the communications window. Click "Refresh" if it does not appear.
- Step 4: The HUB should now appear in the device list with green text and a blue icon. The device is now assigned.

6 Uploading the project file

Once the entire system has been completed, the project file should be uploaded to the HUB. The HUB stores the Room, Channel and Scene information for the system. This information is required for the App to operate correctly.

The "Smartphone/Web Data" tab is used to upload the Project File to the HUB. Once selected, it will open the page as below. Press "Save and Upload Room Data To Bridge" to upload.

Smartphone / Web Data						Room Import	Mappings	Macros	Events	Holiday Exclusions	Room Enables	Firmware
Note: Sorting the Room columns will affect the smartphone order												
Rooms:												
ID	Enabled	Title	Type	Mode								
9	<input checked="" type="checkbox"/>	Hall	Lights	4 Scenes + Off								
17	<input checked="" type="checkbox"/>	Kitchen	Lights	4 Scenes + Off								
25	<input checked="" type="checkbox"/>	Study	Lights	4 Scenes + Off								
33	<input checked="" type="checkbox"/>	Living Room	Lights	4 Scenes + Off								
41	<input checked="" type="checkbox"/>	Snug	Lights	4 Scenes + Off								
49	<input checked="" type="checkbox"/>	Master Bed	Lights	4 Scenes + Off								
57	<input checked="" type="checkbox"/>	Master Ensuite	Lights	4 Scenes + Off								
65	<input checked="" type="checkbox"/>	Master Dress	Lights	4 Scenes + Off								
Channels:												
ID	Enabled	Title	Type									
1	<input checked="" type="checkbox"/>	Spots										
2	<input checked="" type="checkbox"/>	Pendant										
3	<input checked="" type="checkbox"/>	Wall Light										
4	<input checked="" type="checkbox"/>	Uplighters										
5	<input checked="" type="checkbox"/>	SA										
Scenes:												
ID	Enabled	Title										
1	<input checked="" type="checkbox"/>	Scene 1										
2	<input checked="" type="checkbox"/>	Scene 2										
3	<input checked="" type="checkbox"/>	Scene 3										
4	<input checked="" type="checkbox"/>	Scene 4										
Save & Upload Room Data to Bridge												

Type - This will change the appearance of the icon above the keypad on the App. It may also affect the keypad that appears. For example, a room set to "switch" will show two buttons: "on" and "off", whereas a "blind" type room will show three buttons: "open", "stop", and "close".

Mode - The mode of the room is only set when "lighting" is selected as the type. It will set the variety of "keypads" that will appear in the App. Typically, it is best to make this match the physical keypad in the room.

NB

- 1) If there are a specific number of scenes that are not in the standard 4, 7, or 16 layout, then "named scenes" should be selected. Give custom names to the scenes in the room editor, and any number of scenes can be made to appear on the App.
- 2) While the order of the rooms can be changed from this screen, the order of the channels is always fixed. To get channels in a specific order, they must be addressed or mapped in the desired order.

[7 Downloading the project file](#)

If information has been uploaded to the HUB, then it is possible to import the Room, Channel and Scene data into a blank project file.

The tab used for downloading information from the HUB is called "Room Import." Select this tab to open the page below.

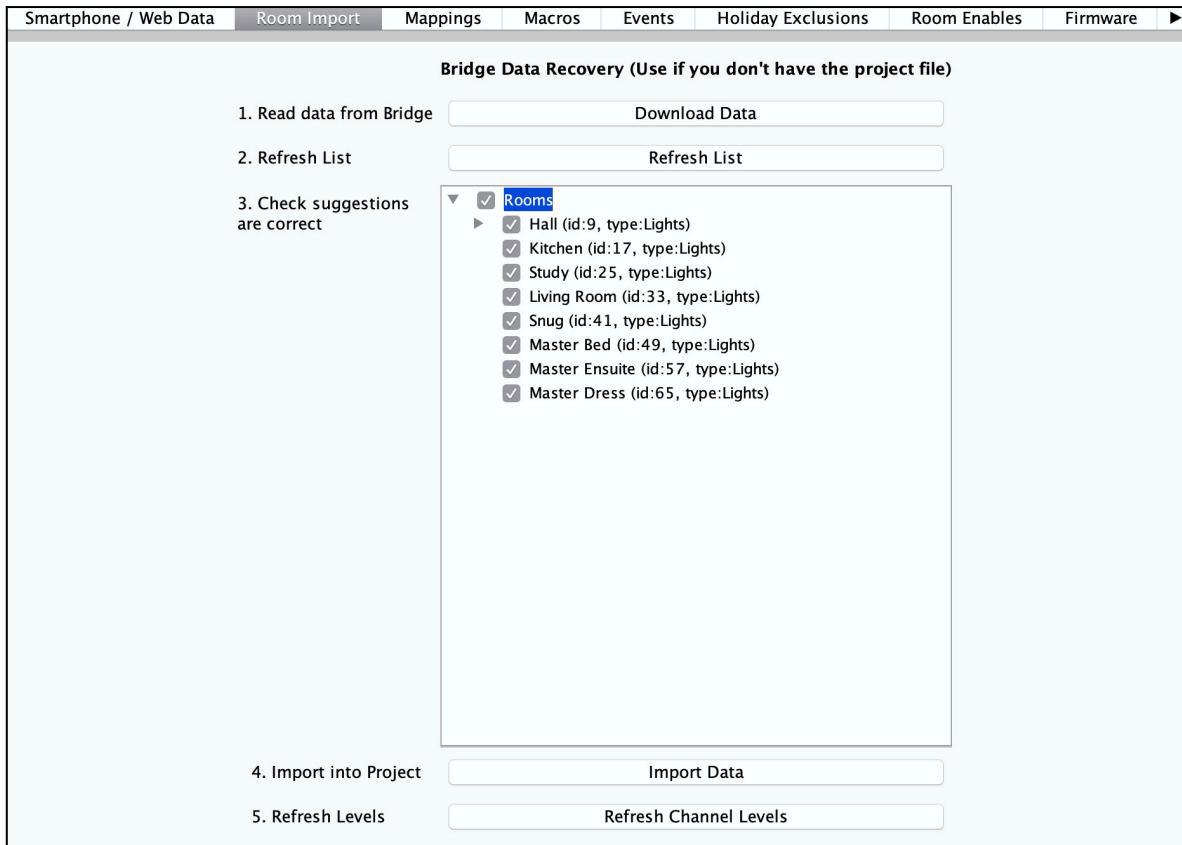

- Step 1: Press “Download Data” at the top of this page. This will open the data for preview in the box below.
- Step 2: Press “Refresh List” if the data does not appear. If no Rooms appear or only “default room” or “test bench,” then there is no information to be downloaded from the HUB.
- Step 3: Press “Import Data” to write the Room and Channel information into the Project File.
- Step 4: Press “Refresh Channel Levels” to download the Scene data into the Project File.

8 Events

Events can be viewed, added, and edited using either Rasoft Pro, the Rako App, or HUB webpages. It should be noted that calendar event conditions can only be set from the HUB web page interface.

The HUB can generate automated Events that trigger commands at specific times. For example, it is possible to automatically turn on the Garden lights at Dusk and turn off the Garden lights at Dawn.

8.1 Setting Events using Rasoft Pro

HUB Events can be viewed and edited using Rasoft Pro. To open the events page in the software, select the HUB in the device editor and select the "Events" tab from the top of the window.

Mappings List: Selects the map to be created/edited and shows a summary of each Event.

Event Trigger/Active Days: Sets the time this event will occur (Dawn, Dusk or a specific time). Also can set the days on which this event will occur.

Output Action: Sets the Action triggered by the Event.

Mappings List:

All Events are listed on the left-hand side of the events tab. Select an event such that it is highlighted to edit the "Event Trigger/Active Days" and "Output Action" sections for this Event.

Event Trigger/Active Days:

"Event Trigger" and "Active Days" are the timing conditions that define when the event will occur.

NB

The dawn and dusk settings can be changed via the location settings in the webpage interface. An offset from this value can be set from this screen if desired.

Output Action

The Output action section on the right-hand side of the screen will define the command to be sent when both the conditions in "Event Trigger" and "Active Days" are met.

NB

The "Action" drop-down menu is used to select the command sent when the event is triggered. Typically, these will be scene commands but it is possible to trigger and control Macros, Holiday settings, etc.

8.2 Setting Events using the Rako App.

Events can also be created via the Rako App. The method to create events in the App is essentially the same as detailed above.

For more information, please refer to the [App User Guide](#).

9 Activities

9.1 Setting Events using Activities

Events can be set via the "Activities" section of the HUB webpages. Navigate to this by selecting "Activities" from the menu on the left-hand side of the HUB web pages and then selecting "Edit" on "Rasoft pro activity".

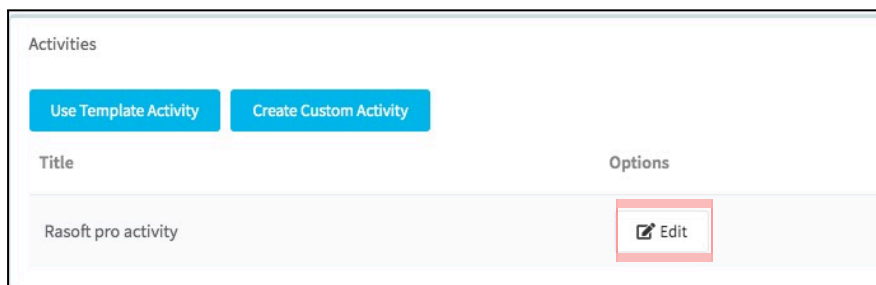

New Activity - Event

Type

Time

Dawn

Dusk

Offset (Minutes)

0

Condition

Day of week condition: Every Day

Output

[Rm:9 Hallway][Ch:1 Downlights] Level: 35%

Type:

This is the time at which the output of the event will occur. It can be defined via a 24 hour clock or in relation to the year round tracked dawn/dusk time internal to the HUB.

Condition:

A condition requirement can be added to the event that needs to be satisfied for the output of the event to occur. This can be a day of the week or a calendar condition.

Output:

The command will be set when "Type" and "Condition" are both met. This will usually be a Scene but can also be a level, fade, etc.

9.2 Setting Audio Activities

The HUB has built-in templates to integrate with third-party audio players, such as Sonos® and BlueSound.





- Step 1: Select the "Activities" section on the HUB webpages.

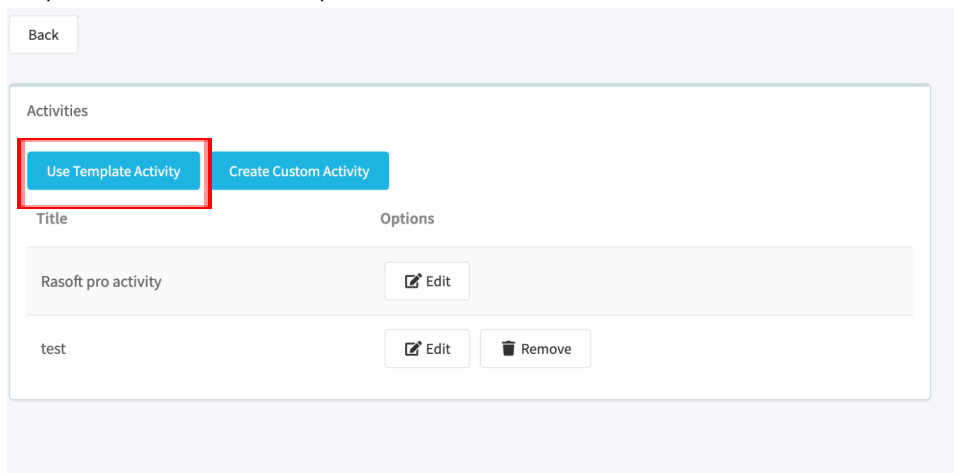

- Step 2: Select "Use Template Activity."



- Step 3: Choose the template that represents the keypad layout required and select 'Create Activity'

Name	Description	Create
	<p>Audio RCM-070-AUDIO: Sonos®</p> <p>7-Button Keypad keypad with Play, Pause, Mute, Next, Previous & Volume engravings</p> <p>Configure the Room and Sonos player that will be used. A virtual room for the audio should be created to continue.</p>	<input type="button" value="Create Activity"/>
	<p>Audio RNC-100-AUDIO: Sonos®</p> <p>10-Button Keypad with lighting control on the left side and 3 favourites, volume engravings on the right side</p> <p>Configure the Room, Favourites and Sonos player that will be used. The favourites in Sonos and a virtual room separate from the lighting should be created to continue.</p>	<input type="button" value="Create Activity"/>
	<p>Audio RCM-070-AUDIO: BlueSound®</p> <p>7-Button Keypad keypad with Play, Pause, Mute, Next, Previous & Volume engravings</p> <p>Configure the Room and BlueSound player that will be used. A virtual room for the audio should be created to continue.</p>	<input type="button" value="Create Activity"/>
	<p>Audio RNC-100-AUDIO: BlueSound®</p> <p>10-Button Keypad with lighting control on the left side and 3 favourites, volume engravings on the right side</p> <p>Configure the Room, Favourites and BlueSound player that will be used. The favourites in BlueSound and a virtual room separate from the lighting should be created to continue.</p>	<input type="button" value="Create Activity"/>

- Step 4: Select 'Get Players'; this will scan the local wired network for audio devices, and choose from the selection.

RCM-070-AUDIO: Sonos®

SONOS

7-Button Keypad keypad with Play, Pause, Mute, Next, Previous & Volume engravings

Configure the Room and Sonos player that will be used. A virtual room for the audio should be created to continue.

Players

Get Players

Room

- Step 5: Select the Virtual Room to which the audio device will be mapped
- Step 6: Select 'Create Activity'

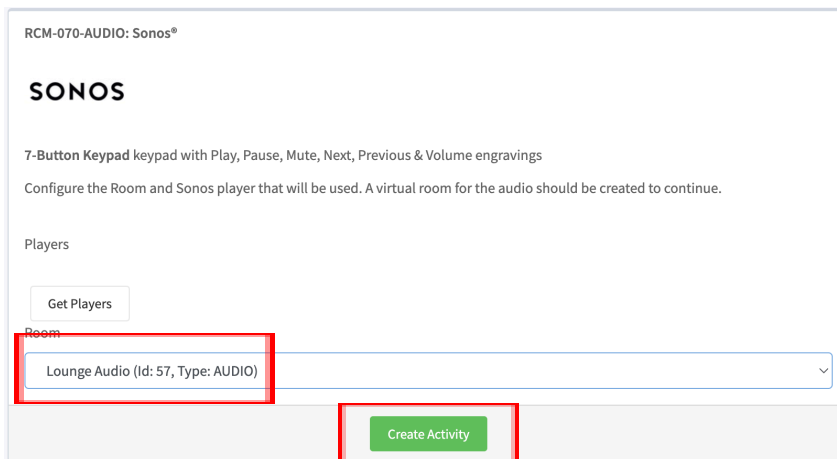

Once the Activity has been created, the Rako Room selected in the Activity will have the commands processed by the HUB, which will communicate with the audio device over IP.

10 Mappings

When Mappings are used, the HUB can “listen” to a Rako command (Source) and perform a certain action (Output Action) every time it is “heard.”



NB

It is usually preferable to use a programmable keypad rather than HUB Mapping when possible. Where WCMs and RNCs are used in the system, use Keypad Mapping rather than HUB Mapping.

10.1 Mapping wireless commands to give multi-room functionality

Wireless commands can be mapped to additional wireless commands to make multiple rooms turn on at once. In the example below, “Hall Scene 1” is mapped to also trigger

“Kitchen Scene 1.”

The screenshot shows the 'Mappings' tab in the HUB device editor. It features a 'Mappings List' on the left, a 'Source/Condition/Active Days' configuration panel in the center, and an 'Output Action' configuration panel on the right. Red boxes highlight these three main sections, with arrows pointing to descriptive text boxes below.

Mappings List: Selects the map to be created/edited and shows a summary of each mapping.

Source/Condition/Active Days: Selects the command that needs to be “heard” for the output action to be triggered. Also the “Condition” and “Active Days” sections can be used so that the map will only trigger at certain times.

Output Action: Selects the action that occurs when the Source command is “heard” assuming the Active Days and Condition are met. The action can range from transmitting a scene to starting/controlling a Macro.

NB

It is also possible to “Enable” and “Disable” maps from other commands via the “Mapping Control” Action.

10.2 Triggering Macros from Maps

When a Macro is used, it must be triggered from a map (this could also be from a WCM map, WAVFR map, etc.). Below Mapping 2 is an example of a map being used to trigger a macro: in this case, “Start Macro 2.”

11 Macros

Macros allow a sequence of actions to take place when triggered by an Event or Map. The HUB can store up to 60 Macros, each of which can have a maximum of 32 steps.

The HUB Macro screen is located on the tab in the HUB device editor.

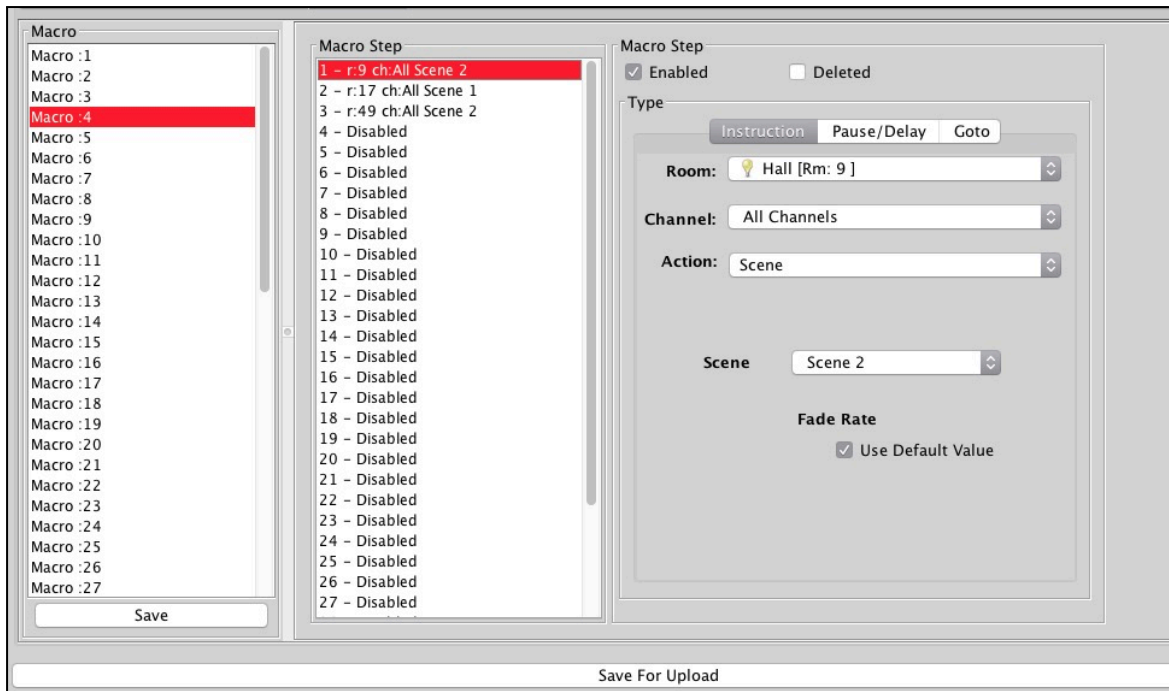

There are 3 steps in this example Macro:

- Room 9, All Channels, Scene 2
- Room 17, All Channels, Scene 1
- Room 49, All Channels, Scene 2

With this simple Macro the HUB will just run through the three commands listed. More complex functionality can be achieved by using the commands in the tables outlined below.

11.1 Writing Macros

Macro steps can be one of four types:

Action	Pause	Delay	Goto
Can be a simple command, including Scenes, Fades etc. Can also include "Macro Control" and "Mapping Control" for more complex programming.	A running Macro will stop at a Pause and remain there until it hears a Continue.	The Macro can wait at this step for a defined period of time. Useful when programming PIR timeouts, etc.	The Macro can be sent to a defined step in this or another Macro.

11.2 Triggering Macros

Macros can be triggered in several ways. Most commonly:

- Wired device direct Map (WCM, WAVFR, etc.)
- HUB Mapping
- HUB Event

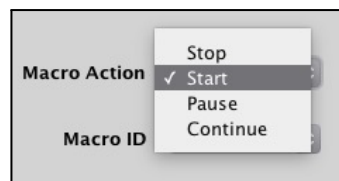

Once a macro trigger is sent, it will perform one of four different functions for a Macro:

Start	Stop	Pause	Continue
This will cause the Macro to start from the beginning (Step 1), regardless of its current position in the Macro.	This will cause a Macro that is already running to Stop running and return to Step 1.	This will cause a Macro to Pause at whatever step it is currently running.	This will cause the Macro to continue from a Paused state, performing the step immediately after this and proceeding.

NB

It is also possible to "Enable" and "Disable" Macros (or parts of Macros) via the "Macro Control" Action.

12 Holiday Mode

Holiday mode allows the HUB to record normal lighting activity in the system over a period of time. This can then be replayed while the property is empty in order to give a realistic impression that it is occupied.

Holiday mode has three states:

- Record: Used to create a log of the system.
- Playback: Used when the house is unoccupied to replay the information gathered in "Record."
- Idle: Used when the system is in normal occupied operation and no recording is being made.

Holiday mode is most easily controlled from the App. However, it is also possible to change the holiday mode state from a keypad map, HUB map, or by selecting commands on the HUB webpages.

NB

For how to control Holiday mode via the App. see ["App User Guide."](#)

13 Upgrading the HUB

Do not update the HUB through RASOFT Pro; always do so through the HUBs webpage.

- Step 1: Access the HUB webpages as shown in [section 3.3](#) of this manual
- Step 2: Using the HUB web pages, select the "Help" section so that you have the page shown below.

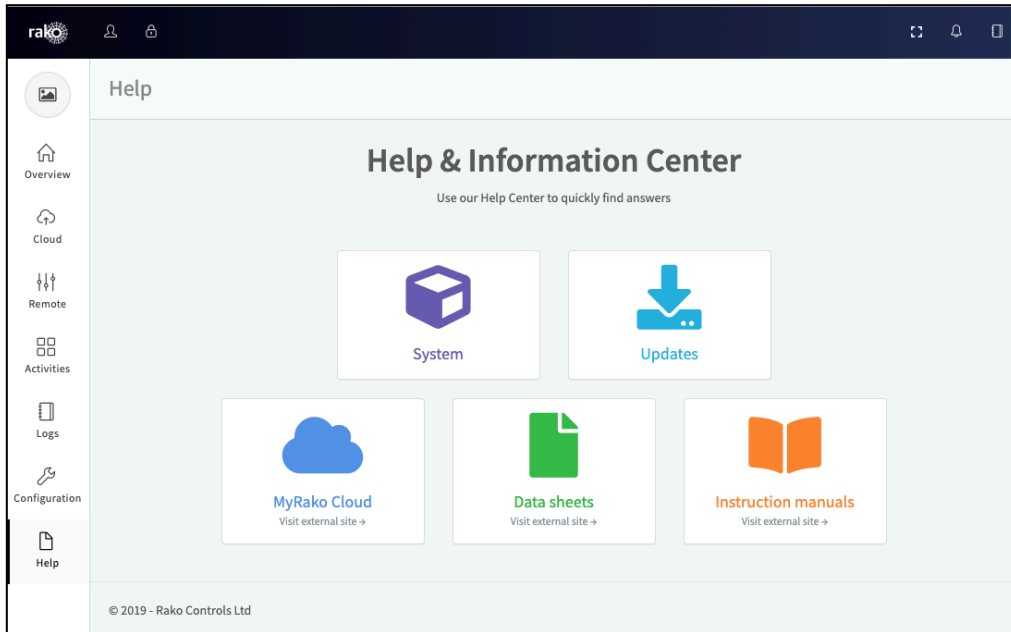

- Step 3: Click on the updates panel.



- Step 4: This will show the current firmware of the HUB as well as the latest version available.

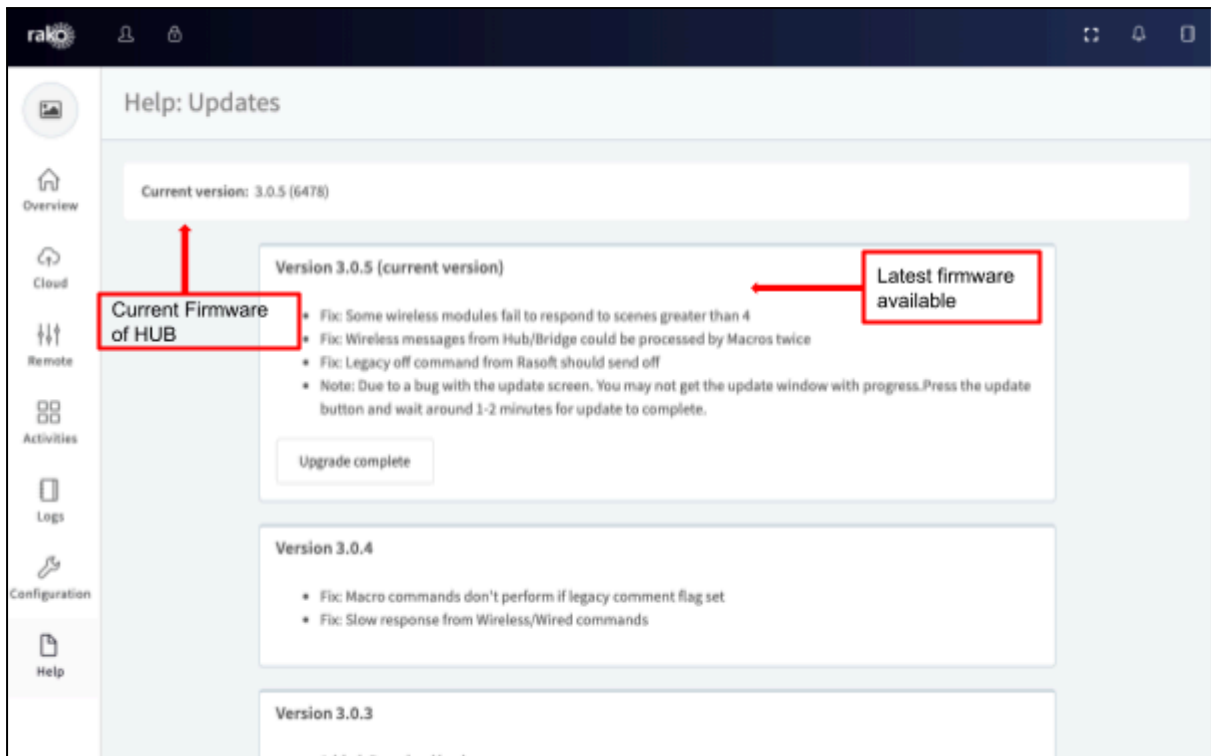

NB

As the HUB is a new product, it will require updates to have all the features available. Complete the following steps to make sure the HUB is updated to the latest firmware and all features are available.

14 UDP Feedback

It is possible to monitor commands received and transmitted by the HUB. This can be done using the UDP Feedback feature.

14.1 Live feedback

In the very bottom right of the software (below the communications window) is the Live Feedback section. Each command received or transmitted by the HUB will appear here, and it is useful for checking commands that have been programmed as desired.

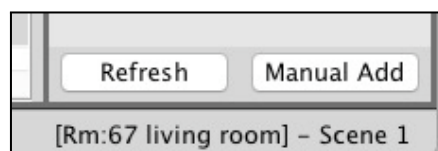

NB

A Bridge or HUB will have to be connected in order to see this feedback.

14.2 UDP feedback log

When more detailed or long-term feedback is required, a log of commands received or transmitted by the HUB can be opened. In the toolbar, select "Window" - "Output" - "Output" to view the page as below:

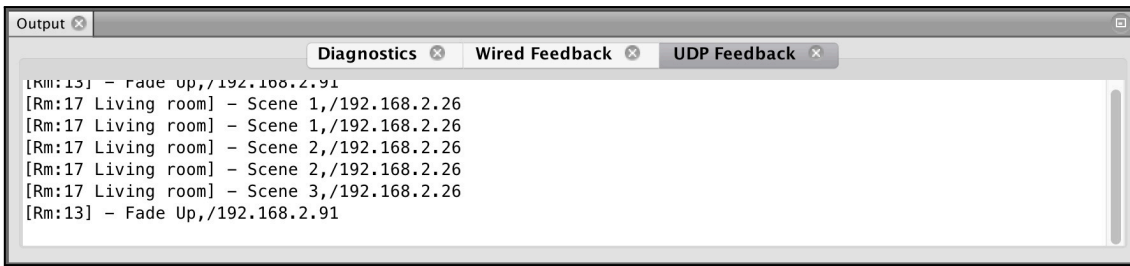

14.3 HUB webpage logs

A timestamped log of system activity can be found within the HUB webpages. These can be accessed by selecting the "Logs" section of the HUB webpages.

Network data			
Type	Title	Description	Time
Web request		[Rm:9]Off	12:37:34
Web request		[Rm:9]Scene 4	12:37:32
Web request		[Rm:9]Scene 3	12:37:30
Web request		[Rm:9]Scene 2	12:37:27
Web request		[Rm:9]Scene 1	12:37:25
Web request		[Rm:9][Ch:7]Level: 0%	12:37:19
Web request		[Rm:9][Ch:7]Level: 100%	12:37:18
Rasoft/Telnet		[Rm:9][Ch:7]Ident	12:10:55
Rasoft/Telnet		[Rm:21]Scene 1	12:08:42
Rasoft/Telnet		[Rm:21][Ch:6]Ident	12:08:39
Rasoft/Telnet		[Rm:21][Ch:6]Ident	11:58:43

As well as a description of the address (Room and Channel) and command, the source of the command can also be viewed.

15 Activity States

The "Activity States" page in the system settings of the HUB webpages is used to trigger Events, Mappings, and Macros. This can be useful for testing purposes, for example, testing Dawn and Dusk Events or Macros.

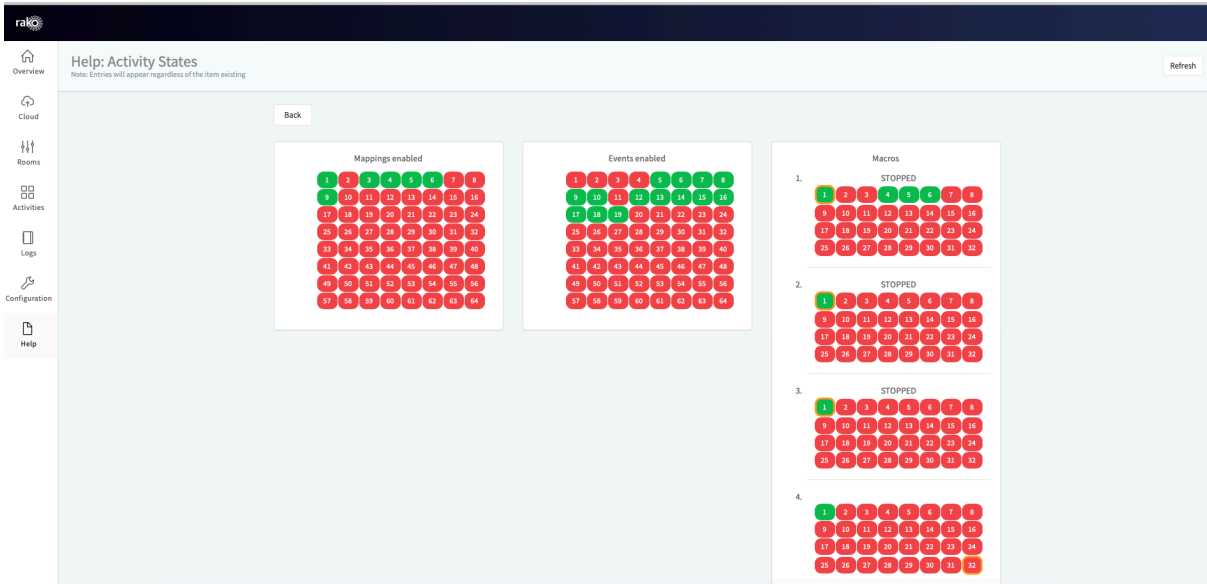

Each green number is an active Mapping, Event, or Macro, and by clicking on the box, it will be enabled. This can be verified by selecting the HUB logs where the command should be visible.

Network data		
Type	Source	Description
	Event	[Bridge] Macro Control Enable 1->1 Step: 1->3

Thank you for choosing Rako Controls; we hope that you are pleased with your system. Should you require further assistance, please contact us via our website, www.rakocontrols.com, or by calling our customer support helpline on 01634 226666.

